

**EMI**<sup>®</sup>  
*Electronics Mart India Limited*



 **pure acoustics**<sup>®</sup>  
 THE PURE SOUNDS OF LIFE



## Supernova 5F Floor-standing Loudspeaker

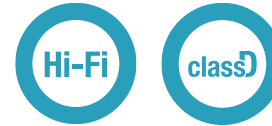

### FEATURES

- Two 6.5" woofers provide realistic sound distribution while maintaining minimal distortion
- 1" silk dome tweeter with oil cooling system for crystal clear highs
- Delivering a robust and controlled audio experience, the system boasts a powerful 220W output
- Piano finish that will enhance any setting

### TECH SPECS

- Power Output: 220 Watts
- Frequency Response: 42Hz-20KHz
- Impedance: 8 Ohm
- Driver Complement: 2 Way- DRAV FIG
- Woofer: 2x6.5"
- Tweeter: 1"
- Product Dimensions: 81 x 33 x 29cm (31 x13 x 11.5in)
- S/N Ratio: 92 db



## Supernova 8F

### Floor-standing Loudspeaker



#### FEATURES

- Three 6.5" woofers offer life like sound dispersion with minimal distortion
- 1" silk dome tweeter with oil cooling system for crystal clear highs
- Powerful 250w output power for robust & controlled audio
- Piano finish that will enhance any setting

#### TECH SPECS

- Power Output: 250 Watts
- Frequency Response: 42Hz-20KHz
- Impedance: 8 Ohm
- Driver Complement: 2 Way- DRAV FIG3/6.5
- Woofer: 3x6.5in
- Tweeter: 1in
- Product Dimensions: 81 x 33 x 29cm
- S/N Ratio: 92 db

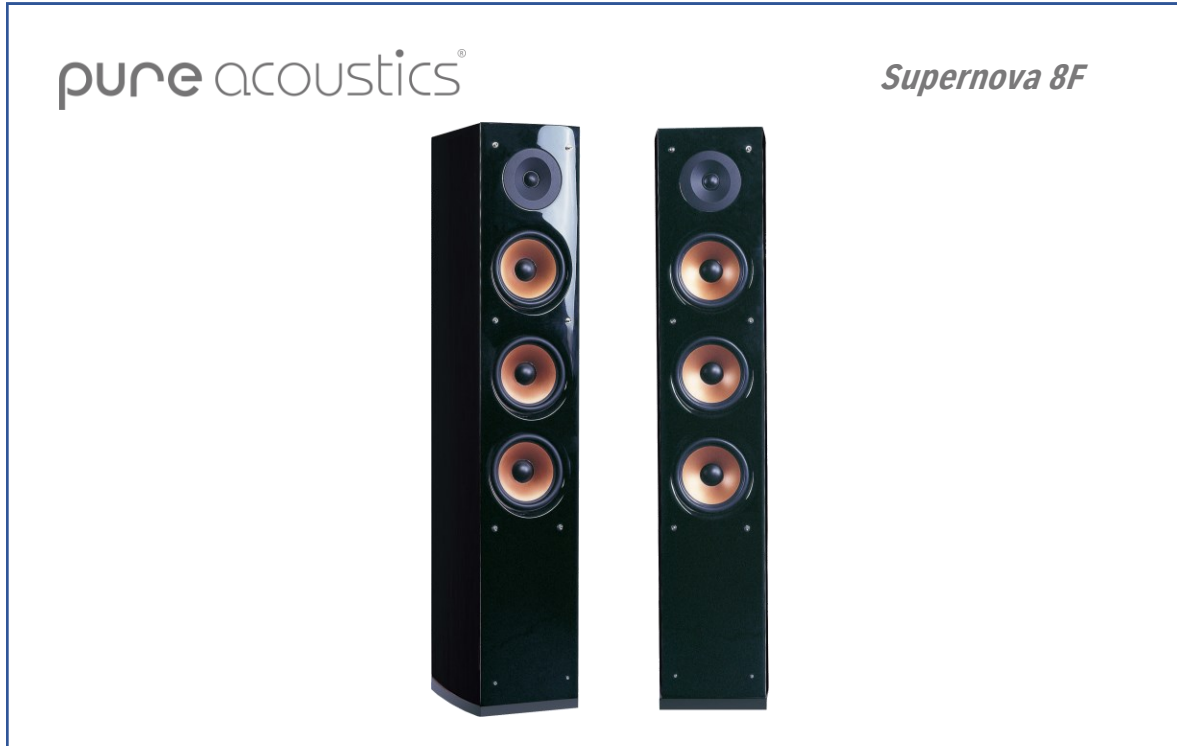

## Supernova S Surround Speaker

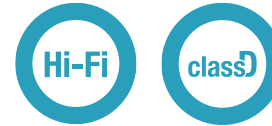

### FEATURES

- One 5.25" woofers offer life like sound effects
- 1" silk dome tweeter with oil cooling system for crystal clear highs
- Powerful 2-way 140W output power provide balanced sound distribution
- Piano finish that will enhance any setting

### TECH SPECS

- Power Output: 140 Watts
- Frequency Response: 65Hz-20KHz
- Crossover Frequency: 3800Hz
- Sensitivity: 89dB
- Impedance: 8 Ohm
- Driver Complement: 2 Way- DRAV FIG 3/6.5
- Woofer: 1x5in midwoofer
- Tweeter: 1in
- Product Dimensions: 31 x 18 x 19cm

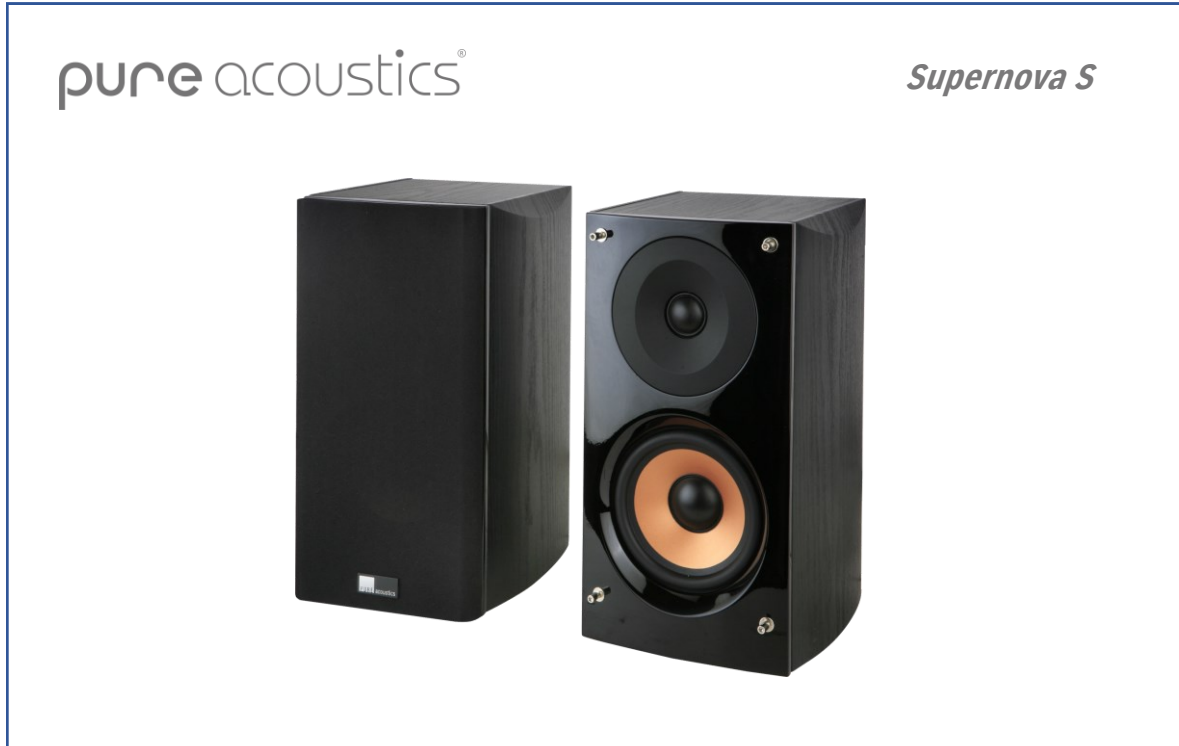

pure acoustics®

*Supernova C*

## Supernova C Center Speaker



### FEATURES

- Two 5.25" woofers offer life like sound dispersion with minimal distortion
- 1" silk dome tweeter with oil cooling system for crystal clear highs
- Magnetically shielded drivers eliminate interference for nearby electronic components
- Powerful 3-way 150w output power provide balanced sound distribution
- Piano finish that will enhance any setting

### TECH SPECS

- Power Output- 150 Watts
- Frequency Response: 60Hz-20KHz
- Crossover Frequency: 3800Hz
- Sensitivity: 89dB
- Impedance: 8 Ohm
- Driver Complement: 2 Way- DRAV FIG
- Woofer: 2x5.25in midwoofer
- Tweeter: 1in
- Product Dimensions: 16 x 46 x 19cm
- Product Weight: 4kg (9lbs)



## **HT-800** *Satelite Speakers*



### **FEATURES**

- *High-Quality 50W satellite speaker*
- *Powerful 2.5" woofer*
- *Easy Installation*
- *Includes swivel bracket*

### **TECH SPECS**

- *Power Output: 50W*
- *Frequency: 50Hz-20kHz*
- *Sensitivity: 88dB±3dB*
- *Impedance: 8Ω*
- *Woofer: 2.5"*
- *Dimensions: 9x9x10cm*

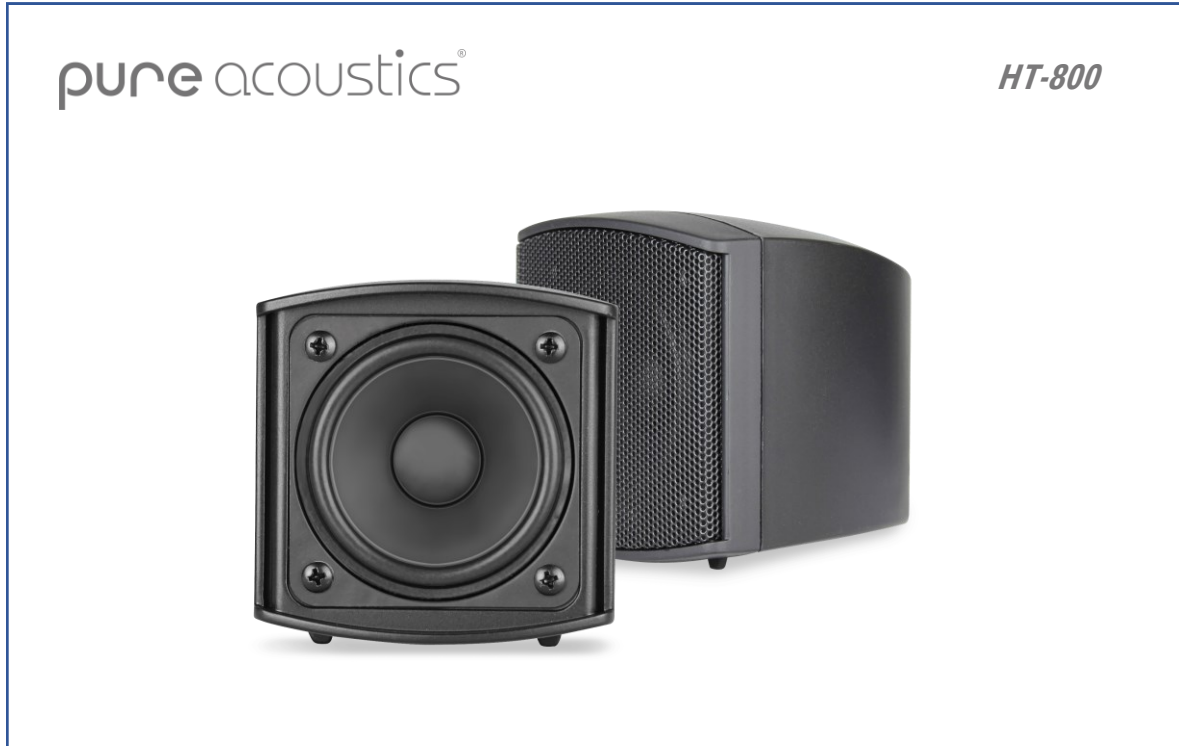

pure acoustics®

SN10 SUB



## SN10 SUB

### 10" 150W Subwoofer

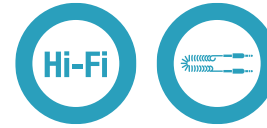

#### FEATURES

- Pure subwoofers allow you to experience the clear, throbbing bass of your favorite music or soundtrack as it was intended.
- With their wide range of woofer sizes and power capabilities, you will have no trouble finding the right model to complete your home theater or stereo system.
- Massive amplifiers provide the right combination of stability and power even at the lowest frequencies and highest volumes, drenching you with an all-encompassing splash of sound.

#### TECH SPECS

- Power Output: 150W
- Frequency Response: Adjustable 40hz ~180khz
- Impedance: 8 ohm
- Power Supply: 110 or 220 volts
- Dimensions: 33.5 x 29 x 36 cm
- Connections: RCA Connector



pure acoustics®

Rift 125



## Rift 013 (Rift 125 / IC125) 3" In-Ceiling Speaker (each)



### FEATURES

- In-ceiling speaker with super thin grill
- 3" Round grill suitable for small rooms with limited space
- 50W Balanced sound
- Small holes in the grill make it practically invisible
- Quick connect terminal for easy installation
- Strong, quick release clips for one-step installation

### TECH SPECS

- Power Output: 50W
- Woofer: 3"
- Sensitivity: 83dB ± 3dB
- Impedance: 8Ω
- Frequency Response: 120Hz – 20 KHz ± 3dB
- Cutout Dimension: 8.6cm (3.38")
- Gross Dimensions: 10cm (3.94")
- Depth: 5.25cm (2.06")



Installation Clasps



Lay-Flat Grill



Gold Plated Terminals

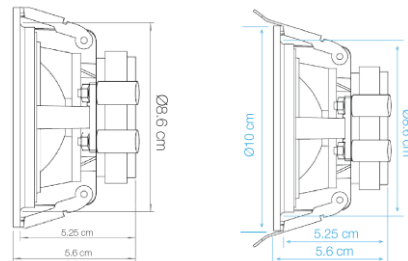



pure acoustics®

Rift RW052



## Rift RW052 (RW-052)

5.25" magnetic grill in-ceiling speaker (each)



### FEATURES

- 80W Power
- 5.25" woofer
- Easy quick fit clips mechanism
- White or black magnetic grill

### TECH SPECS

- Power: 2-Way 80W
- Impedance: 8  $\Omega$
- Woofer: 5.25"
- Twitter: 0.5"
- Frequency Response: 40Hz-20KHz+3db
- Sensitivity: 88dB $\pm$ 3dB

- Cutout Dimension: 17.5cm (6.89")
- Gross Dimension: 19.6cm (7.71")
- Depth Dimension: 7.7cm (3.03")



pure acoustics®

Rift RW065



## **Rift RW065 (RW-065 / IC-365)** *6.5" magnetic grill in-ceiling speaker (each)*



### **FEATURES**

- Iron frame
- 1" dome tweeter
- 6.5" woofer
- Easy quick fit clips mechanism
- Magnetic grill

### **TECH SPECS**

- Power: 120W
- Impedance- 8 ohm
- Woofer-6.5"
- Tweeter-1"
- Frequency Response: 48Hz-20Hz+3dB
- Sensitivity: 88dB+3dB
- Cutout Dimension: 20cm (7.87")
- Gross Dimension: 22.5cm (8.85")
- Depth Dimension: 9.5cm (3.74")

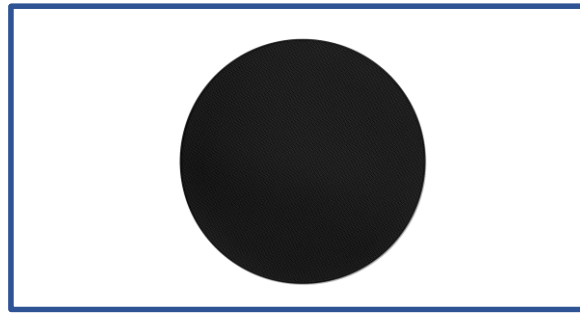

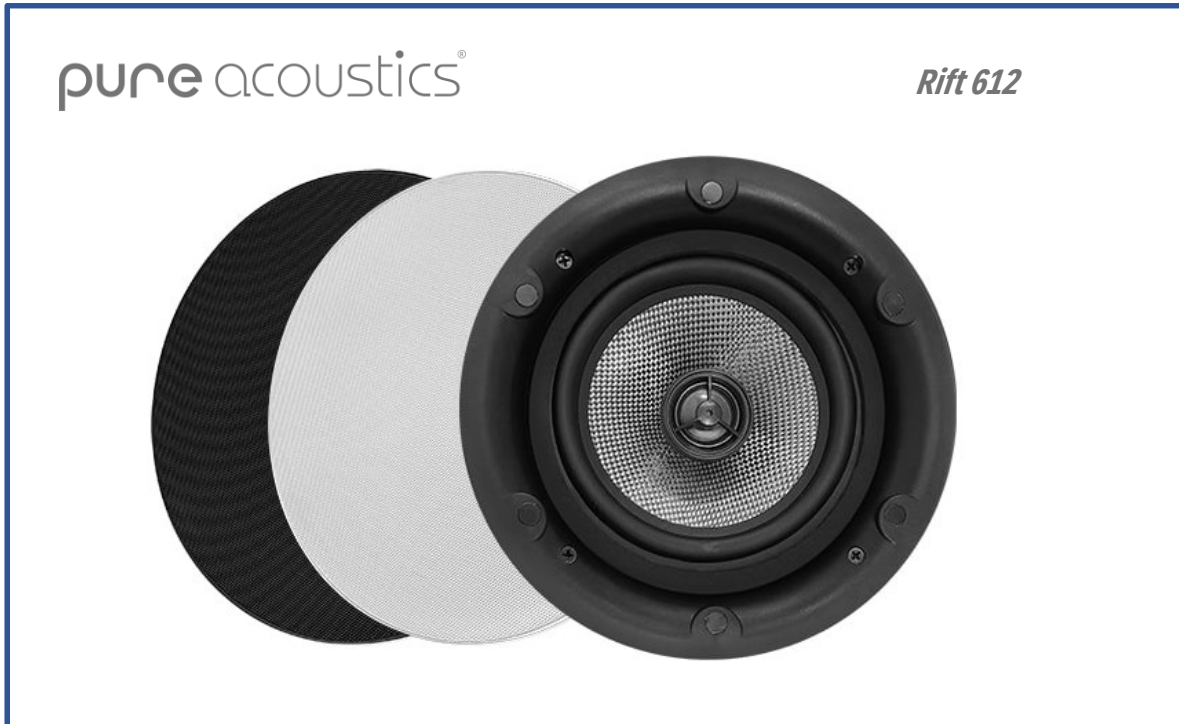

## Rift 612 (IQ-612)

6.5" magnetic grill in-ceiling speaker (each)



### FEATURES

- Speakers with ultra-thin magnetic grill
- 2-way Kevlar Woofer
- Dome Tweeter
- Excellent solution suitable for wall/ceiling and used as rear speakers
- 12dB crossover for accurate frequency balancing
- Grill with small holes and acoustic fabric, for a clean and delicate look and quality sound
- Finish in two colors: Black/White

### TECH SPECS

- Power: 2-Way 120W
- Woofer: 6.5" PP cone woofer
- Tweeter: 1"
- Impedance: 8Ω
- Frequency Response: 30Hz-20KHz±3dB
- Sensitivity: 86dB±3dB
- Cutout Dimension: 20cm (7.87")
- Gross Dimension: 22.5cm (8.85")
- Depth Dimension: 9.5cm (3.74")





## Rift 614 (IQ614)

6.5" magnetic grill in-ceiling speaker (each)



### FEATURES

- Speakers with ultra-thin magnetic grill
- 2-way woofer cavalier speakers
- Dome Tweeter
- Excellent solution suitable for wall/ceiling and used as rear speakers
- 12dB crossover for accurate frequency balancing
- Grill with small holes and acoustic fabric, for a clean and delicate look and quality sound
- Finish in two colors: black/white

### TECH SPECS

- Power: 2-Way 150W
- Woofer: 6.5"
- Tweeter: 1" Dome
- Impedance: 8Ω
- Frequency Response: 48Hz-20KHz±3dB
- Sensitivity: 88dB±3dB
- Cutout Dimension: 200mm (7.9")
- Gross Dimension: 244mm (9.6")
- Depth Dimension: 98.8mm (3.89")

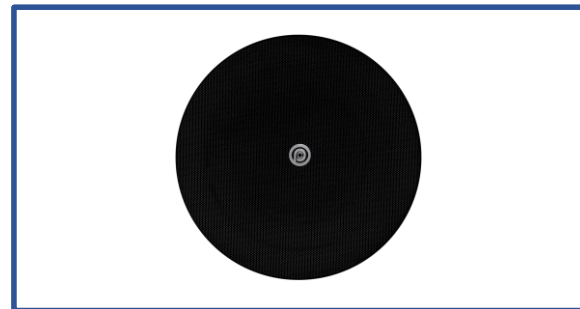



## BOOST-55

5.25" 2-way magnetic grill in-ceiling speaker (each)



### FEATURES

- Slim 1.50 cm Iron frame
- 1" dome tweeter
- 5.25" PP cone woofer
- Easy quick fit clips mechanism
- Thin magnetic grill
- Easy installation
- Sleek design

### TECH SPECS

- Power: 2-Way 100W
- Woofer: 5.25"
- Tweeter: 1" Dome
- Impedance: 8Ω
- Frequency Response: 75Hz-20KHz±3dB
- Sensitivity: 88dB±3dB
- Crossover Detwork: 12dB±2dB

- Cutout Dimension: 16.6cm
- Gross Dimension: 20.2cm
- Depth Dimension: 7.8cm



## **BOOST-65**

*6.5" 2-way magnetic grill in-ceiling speaker (each)*



### **FEATURES**

- Slim 1.50 cm Iron frame
- 1" dome tweeter
- 6.5" PP cone woofer
- Easy quick fit clips mechanism
- Thin magnetic grill
- Easy installation
- Sleek design

### **TECH SPECS**

- Power: 2-Way 120W
- Woofer: 6.5"
- Tweeter: 1" Dome
- Impedance: 8Ω
- Frequency Response: 60Hz-20KHz±3dB
- Sensitivity: 90dB±3dB
- Crossover Network: 12dB±2dB

- Cutout Dimension: 20.2cm
- Gross Dimension: 23.8cm
- Depth Dimension: 8.6cm



## Rift T800 (Turbo 800)

8" 2-way in-ceiling 2x magnetic grill (each)



### FEATURES

- Woofer: 8"
- Tweeter: Dome 1"
- 2-Way 185W 8Ω
- Easy installation
- Premium Sound Quality
- Quick-fit security legs
- Magnetic grill
- 12dB Crossover

### TECH SPECS

- Power: 2-Way 185W
- Woofer: 8"
- Tweeter: 1" Dome
- Impedance: 8Ω
- Frequency Response: 40Hz-20KHz±3dB
- Sensitivity: 90dB±3dB
- Crossover Network: 12dB±2dB

- Cutout Dimension: 22.9cm
- Gross Dimension: 25.4cm
- Depth Dimension: 8.7cm





## **Rift 88 (IQ-814)**

8" 2-way in-ceiling 2x magnetic grill (each)



### **FEATURES**

- Power Output: 2-Way 200W
- Frequency Response: 30Hz-20KHz  $\pm$  3dB
- Sensitivity: 90dB  $\pm$  3dB
- Impedance: 8 $\Omega$
- Woofer: Kevlar 8"
- Tweeter: 1" Dome
- Crossover network: 12dB+2dB

### **TECH SPECS**

- Power: 2-Way 200W
- Woofer: Kevlar 8"
- Tweeter: Dome 1"
- Impedance: 8 $\Omega$
- Frequency Response: 30Hz-20KHz  $\pm$  3dB
- Sensitivity: 90dB  $\pm$  3dB
- Crossover Network: 12dB  $\pm$  2dB

- Cutout Dimension: 24.1cm
- Gross Dimension: 27.2cm
- Depth Dimension: 11cm

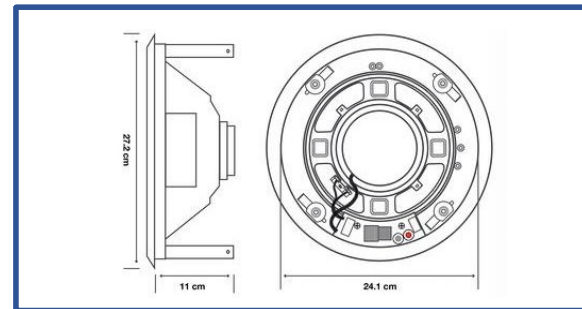



## **Rift 89 (IW-89 / WB-656)** **6.5" in-wall speaker (pair)**



### **FEATURES**

- Professional 2-way speaker configuration
- Ultra-thin magnetic grill offers a clean aesthetic finish on all wall types
- High performance 12dB crossover produces sharply defined highs and lows
- Iron frame
- Dome tweeter
- 6.5" PP cone woofer
- Easy quick fit clips mechanism
- Easy installation

### **TECH SPECS**

- Power: 2-Way 150W
- Woofer: 6.5"
- Tweeter: 0.75" Dome
- Impedance: 8Ω
- Frequency Response: 43Hz-20KHz±3dB
- Sensitivity: 90dB±3dB
- Crossover Network: 12dB±2dB
- Product Dimension: 30.7x20.7x8.2cm
- Cutout Dimension: 27x17x7.8cm

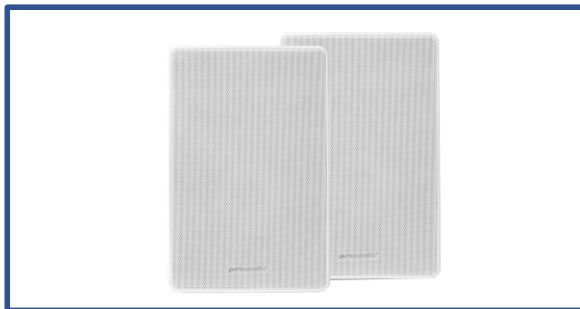
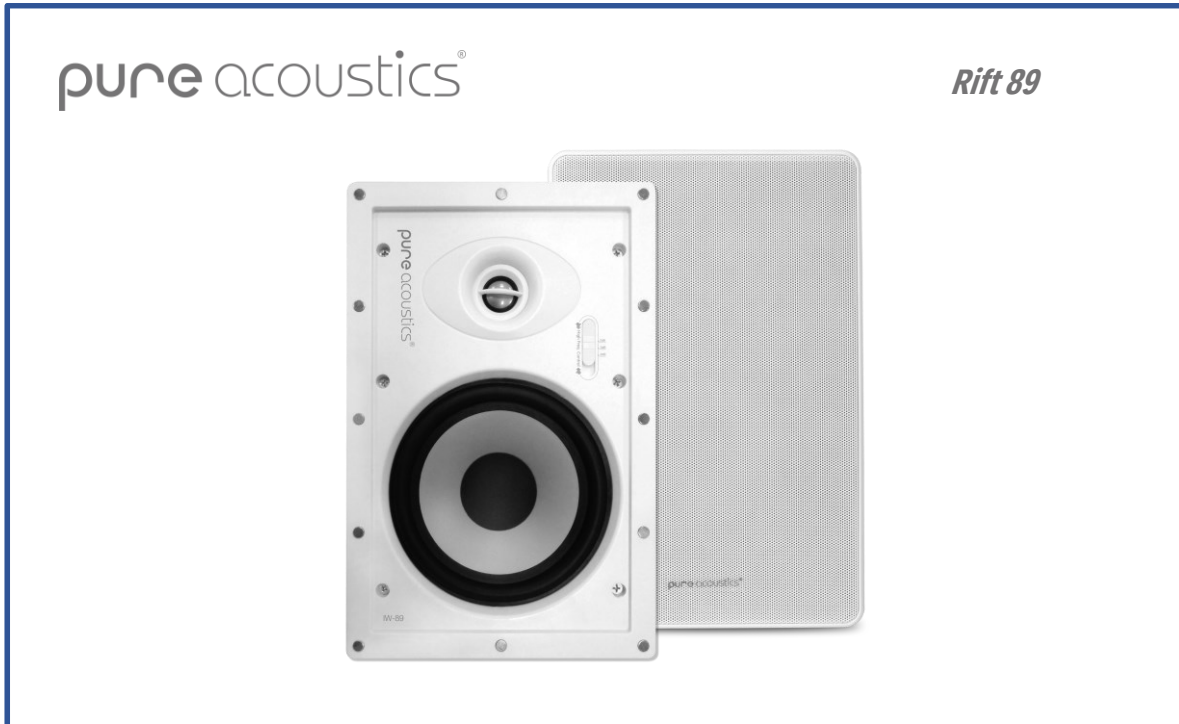

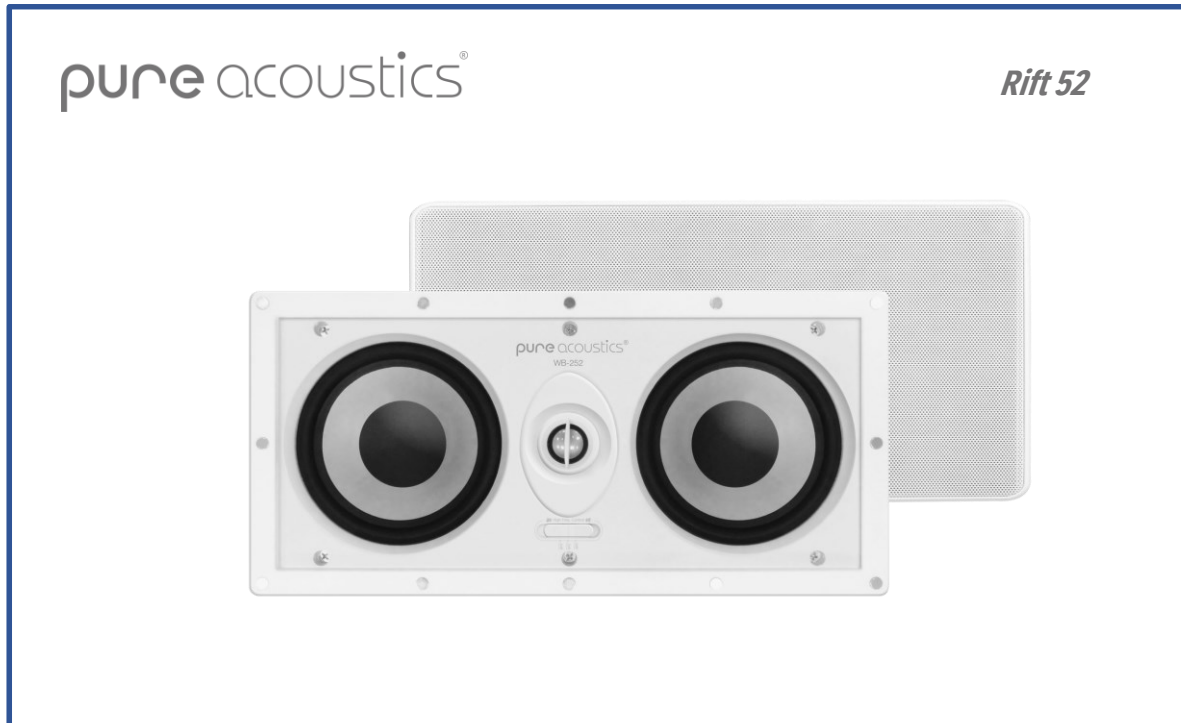

## Rift 52 (WB-252)

2 x 5.25" in-wall center speaker (each)



### FEATURES

- Professional 2-way speaker configuration
- Ultra-thin magnetic grill offers a clean aesthetic finish
- High performance 12dB crossover produces sharply defined highs and lows
- "Push N' Connect" terminals provide an efficient time saving cable connection solution
- 6 premium mounting clamps guarantee the speaker remains securely in place
- Installation template included for a precise installation in the wall

### TECH SPECS

- Power: 2-Way 165W
- Woofer: 5.25" x 2
- Tweeter: 0.75" Dome
- Impedance: 8Ω
- Frequency Response: 49Hz-20KHz±3dB
- Sensitivity: 88dB±3dB
- Crossover Network: 12dB±2dB
- Product Dimension: 37.3x18.7x7.7cm
- Cutout Dimension: 33.7x15.2x7.3cm

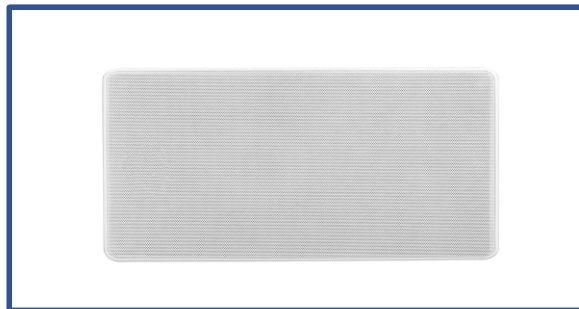

pure acoustics®

PX465



## PX465

### 6.5" 2-way Outdoor speaker (pair)



#### FEATURES

- A pair of speakers with extremely high sound quality, for a dynamic and open sound
- Non-rusting aluminum mesh
- Includes stainless steel grill that meets the highest standards
- The speaker has an IP-65 standard
- Specially designed to withstand all weather conditions (sprinkler systems, water jets, etc.)
- 6.5" woofer, titanium tweeter 1"
- Gold connectors to prevent corrosion
- Includes brackets for horizontal vertical hanging
- Horizontally /vertically adjustable speaker icon
- Finish: black/white

#### TECH SPECS

- Power: 150W RMS
- Woofer: 6.5"
- Titanium Tweeter: 1"
- Resistance: 8Ω

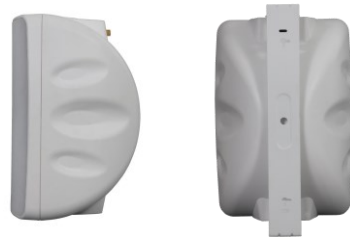

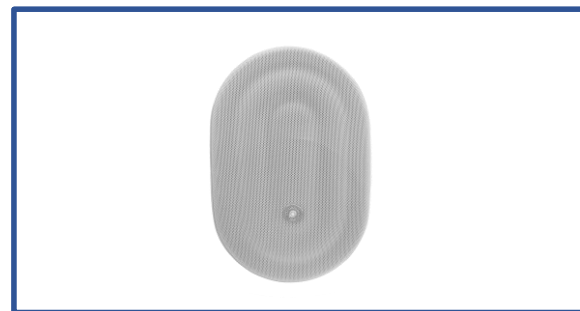

## Calisto

6.5" Bluetooth Outdoor speaker pair (1 active 1 passive)



### FEATURES

- Bluetooth 4.0 high-definition wireless music streaming
- High performance 6.5" woofer driver with rubber surround delivers crystal clear sound and ultra-low distortion
- Titanium dome tweeter delivers crystal clear highs
- Anti-rust aluminum grill with swivel logo
- Premium UV coated cabinet prevents discoloration over time
- 2-Way full frequency range speaker configuration
- Tone control - independent Bass, treble and master volume controls
- Premium 12dB crossover delivers ultra-accurate signal distribution across the frequency range
- Simple do it yourself installation
- Unique 360-degree flex-mount for multi directional mounting

### TECH SPECS

- IPX6
- Bluetooth 4.0
- Power: 120 Watt
- Frequency Response : 55 hz – 20Khz
- Impedance: 8 ohm
- Sensitivity: 89db +/- 3
- Woofer: 6.5"
- Tweeter: Dome 1"
- Voltage: 110v/220v
- Size: 19.7 x 30.6 x 20.9 cm

pure acoustics®

Blyss (OD645)



## Blyss (OD645)

6.5" Outdoor speaker Diamond grill (each)



### FEATURES

- Outdoor speaker IP55 standard resistant to all weather conditions (strong sun, moisture, rain, and more ...)
- 2-WAY speaker 6.5" woofer adapted for playing music in open areas and large spaces
- Non-rusting aluminum diamond grill
- Gold-plated terminals wrapped for anti-corrosion
- Easy installation that allows vertical and horizontal hanging (hanging brackets are included in the package)
- Available in 2 colors -black and white finish

### TECH SPECS

- Power: 150W RMS
- Sensitivity: 88dB±3dB
- Woofer: 6.5"
- Frequency Response: 60Hz-20kHz±3dB
- Tweeter: 0.5"
- Resistance: 8Ω

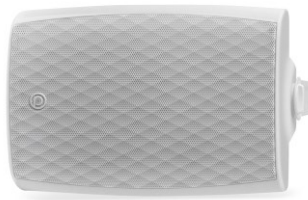

pure acoustics®

*Blyss R8BT*

## ***Blyss R8BT (Rock-185BT)***

*8" BT outdoor rock speaker pair (1 active 1 passive)*



### **FEATURES**

- *Weatherized speakers-Resistant to all weather conditions*
- *Powerful- 200W power handling*
- *Natural finish- Blends effortlessly into landscape or garden*
- *Easy installation -Vertical and horizontal hanging*

### **TECH SPECS**

- *Power Output: 200W*
- *RMS Resistance: 8Ω*
- *Sensitivity: 88dB±3dB*
- *Woofer Diameter: 8"*
- *Tweeter Diameter: 1mm*
- *Frequency Response: 50Hz-20kHz±3dB*

pure acoustics®

Quantum WMB23



## Quantum WMB23

WiFi Wireless Audio Music Receiver 2.4G+ 5G  
version Airplay2

### FEATURES

- Support WIFI 2.4G &5G / Bluetooth / AUX/ Optical fiber / LAN
- Support linkplay multi-room
- Support Airplay2, DLNA
- Streaming music from iHeartRadio, Spotify, TIDAL, Napster, Qobuz, Amazon Music, QQ music, Online Radio etc.

### TECH SPEC

- Power: 5V – 1.5A
- Frequency: 20Hz-20kHz
- THD: 0.03%
- SNR: >95db
- Remote Control
- Type-C Power Connectivity





## Quantum B250

### Hi-Fi Bluetooth Stereo Audio Amplifier

#### FEATURES

- Support Bluetooth 5.0, RCA / HDMI ARC / LAN / Optical Fiber input
- 2X50W(4Ω), DC 24V-4A
- Support Speaker R+L / Woofer /RCA output
- USB Speaker, USB playback, Dual Microphone, Microphone optional, Karaoke function
- Supports BASS /TREBLE adjustment and microphone volume/reverb intensity adjustment
- Equipped with full frequency stereo output
- IR remote control

#### TECH SPEC

- Audio Input: Bluetooth 5.0 / RCA / HDMI ARC / Optical / USB Speaker / USB playback
- Audio Output: SPEAKER R+L / RCA / Woofer
- Audio Decoding: MP3 / WMA / SBC / WAV / FLAC / AAC / AIF / AMR / APE
- Operating Voltage: DC 24V-4A
- Output Power: 2×50W (4Ω)
- Frequency Response: 20Hz-20kHz
- THD+N Ratio: 0.03%
- SNR: 95db
- Dimension: 19.8cm×19.8cm×4.6cm





pure acoustics®

Quantum W275



## Quantum W275

### Hi-Fi WiFi Bluetooth Stereo Audio Amplifier

#### FEATURES

- Support WiFi 2.4G & 5G / Bluetooth 5.0 / Vinyl MM / Aux in / Optical Fiber input / HDMI ARC / LAN / USB
- Support SPEAKER R+L / RCA output / Woofer output / Optical output
- 2 \*275W (4Ω)
- Support linkplay multi-room
- Support Airplay2
- Support DLNA, AirPlay, iHeartRadio, Spotify, TIDAL, Napster, Qobuz, Amazon Music, QQ music, Online Radio etc.
- Support IOS / Android
- Built-in RIAA balanced amplifier circuit
- Equipped with full frequency stereo output
- Support 24Bit, 192khz

#### TECH SPEC

- Operating Voltage: AC 100V ~240V
- Output Power: 2 x275W (4Ω) 2 x150W (8Ω)
- Frequency Response: 20Hz – 20kHz <math>\pm 2\text{dB}</math>
- Harmonic Distortion: 0.03%
- SNR: 90db
- RCA Input Sensitivity: 1V
- Optical Fiber Output: 0db(1khz 0db)
- Speaker Impedance: 2-16Ω
- Vinyl Input Sensitivity: MM Phono–5mV
- RCA Output Rated Level: 1Vrms (1khz 0db)
- Music source: Spotify, iHeartRadio, Amazon music, TIDAL, Napster, Tuneln, Qobuz, Qplay
- Music streaming protocol: Airplay, DLNA, QPlay, UPnP
- Audio format: MP3 / AAC / FLAC / ALAC / WMA / APE / WAV / OGG, etc.
- Size: 32cm×20cm×6cm
- Weight: 3.4kg (with packaging)

